

HT3000 Cloud HMI User Manual

Human Machine Interface

High-speed & HD HMI User Manual

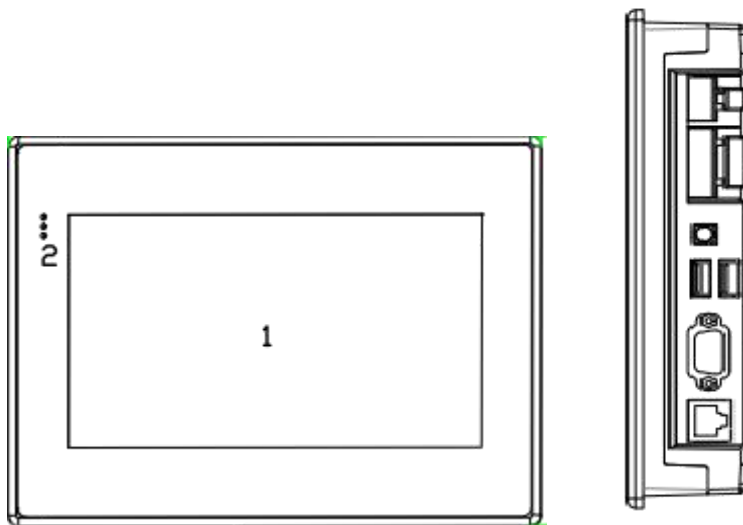

Contents

Product Description

1. Product Introduction.....	3
2. Product Specifications.....	3
3. HMI Bundled software.....	4
4. HMI interface diagram.....	5

Software Instructions

1. HMI connection settings.....	6
a. Notes and hardware installation steps.....	6
● Notes.....	6
● Hardware installation steps.....	6
b. Hardware wiring.....	6
● Devices connection with power.....	6
● Devices connection.....	6
c. Network connection.....	6
2. Project running.....	7
a. Select device models.....	7
b. Download project.....	8
c. Run project.....	8
3. HTCloud manager.....	8
a. Enter device manager interface.....	8
● Local manger.....	8
● Could manager.....	9
b. Excute device management.....	9
● Download project.....	9
● Upload project.....	9
● Offline update.....	10
● Start calibration.....	10
● Update device-time.....	10
● Get the PN code.....	10
● Check the device version.....	11
● Upload the history record.....	11
● Restart the device.....	12
4. Background settings.....	13
a. Project Settings.....	13
● Connect Network Engineering.....	13
● Download project.....	13
b. Network Settings.....	15
● Ethernet connection.....	15
● WI-FI settings.....	15
● Personal hot spot.....	17
● Network configuration model.....	18
● Routing configuration.....	19
c. Settings.....	22
● Settings.....	22
● Security settings.....	23
● Others.....	25
● System Information.....	26
● Cloud settings.....	27
● Multi-language settings.....	28
● Exit background settings.....	28

Product Description

1. Product Introduction

- Main function

HT3000 Embedded System is an embedded system software running in industrial automation monitoring and management equipment. Through running HTCloud Designer project, it can visually observe the situations of the industrial scene and communicate with various industrial control equipment, by the collected production signals of industrial sites to achieve monitor. The alarm information of the industrial site is promptly notified to the relevant staffs through the form of screen, computer language, WeChat, SMS, and mail. Support the function of network project, so that multiple devices can be mutually client and server, share data through the network to realize distributed control. Also support recording and storing data. Analyze and record the real-time working condition data and historical working condition data to solve production failures, improve production efficiency and product quality.

HT3000 high-speed version is a new series of HMI launched by HNC. in 2019, based on the original HMI system to improve the speed of the HT3000 series, and on the basis of HT3000 to optimize the definition of HD version HT3000-H series.

- Technical characteristics

HT3000 embedded system is based on embedded Linux system development, integrated SVG image editing and processing technology, TCP / IP network communication technology, serial communication technology, multi-threading, multi-process, Javascript extended script analysis and running engine and other technologies for development.

2. Product Specifications

Specification	Model	HT3000-7 HT3000-7E	HT3000-7W HT3000-7EW	HT3000-H7 HT3000-H7EW	HT3000-10 HT3000-10E	HT3000-10W HT3000-10EW
Display	Display	7 " TFT		7 " TFT		10.1 " TFT
	Resolution	800x480pixels		1024x600pixels		1024x600pixels
	Colors	16.7M				
	Brightness(cd/m ²)	300		300		350
	Contrast Ratio	800:01:00		800:01:00		500:01:00
	Touch Type	Resistive Type				
Backlight	Backlight Type	LED				
	Backlight Life Time	20,000 Hours				
	Automatic Dormancy	Support and Configurable				
Software	Management software HTCloud Designer					
Memory	Flash	4GB				
	RAM	512M				
I/O Port	Micro SD Card Slot	Support				
	SIM Card	Support 4G network				
	Ethernet Port	10/100 Base-T				
	COM port	RS485/RS232				
	USB HOST	USB2.0 x 2				
	Print Port	COM Port/USB Print				
Power	Input power	24±20%VDC				
	Power Consumption	7W		7W		10W
	Power Isolation	Built-in				
	Voltage Resistance	500VAC				
	Isolation Resistance	Exceed 50MΩ @500VDC				
	Vibration Endurance	10 ~ 25 Hz (X, Y, Z direction 2G/30 minutes)				
Environment	Cooling Type	Natural air Cooling				
	Protection Structure	IP65				
	Storage Temperature	-20 ~70℃				
	Operating Temperature	-10℃ ~ 60℃				
	Relative Humidity	10 ~ 90%RH (non-condensing)				
Specification	Enclosure	Engineering Plastic ABS (Flame-retardant level)				
	Dimensions	200x146x37mm		200x146x37mm		270x212x35mm
	Panel Cutout	193x138mm		193x138mm		260x202mm
	Weight	0.8kg		0.8kg		1.3kg
	Network	WI-FI (Optional)	802.11b/g/n			
Wireless (Optional)		4G/3G/2G				

7" IOT Cloud HMI——High Speed

Model	TFT screen	Storage	LAN	USB	COM	WI-FI	Wireless	Hole Size	Dimension W*H*D
HT3000-7	7" 800*480	4G + 512M + SD	1	2	3			193x138	200x146x37mm
HT3000-7W	7" 800*480	4G + 512M + SD	1	2	3	Yes			
HT3000-7E	7" 800*480	4G + 512M + SD	1	2	2		Global 4G/3G/2G		
HT3000-7EW	7" 800*480	4G + 512M + SD	1	2	2	Yes	Global 4G/3G/2G		

7" IOT Cloud HMI——HD

Model	TFT screen	Storage	LAN	USB	COM	WI-FI	Wireless	Hole Size	Dimension W*H*D
HT3000-H7	7" 1024x600	4G + 512M + SD	1	2	3			193x138	200x146x37mm
HT3000-H7W	7" 1024x600	4G + 512M + SD	1	2	3	Yes			
HT3000-H7E	7" 1024x600	4G + 512M + SD	1	2	2		Global 4G/3G/2G		

10.1" IOT Cloud HMI——High Speed

Model	TFT screen	Storage	LAN	USB	COM	WI-FI	Wireless	Hole Size	Dimension W*H*D
HT3000-10	10.1" 1024x600	4G + 512M + SD	1	2	3			260x202	270x212x35mm
HT3000-10W	10.1" 1024x600	4G + 512M + SD	1	2	3	Yes			
HT3000-10E	10.1" 1024x600	4G + 512M + SD	1	2	2		Global 4G/3G/2G		
HT3000-10EW	10.1" 1024x600	4G + 512M + SD	1	2	2	Yes	Global 4G/3G/2G		

3. HMI Bundled software

- HT3000 needs to be used with HTCloud Designer editing software. Please download from HNC official website: <http://www.hncelectric.com/>.
- It is also recommended to download HNC Cloud APP "IoTBus"
- HNC Cloud APP "IoTBus" download:
 - ✓ Login and download from HNC Cloud website: <http://www.iotbus.net/#/login?language=en>
 - ✓ For iOS terminal, it can search and download "IoTBus"APP in Apple App Store.
 - ✓ Scan the QR code below to download.



4. HMI interface diagram

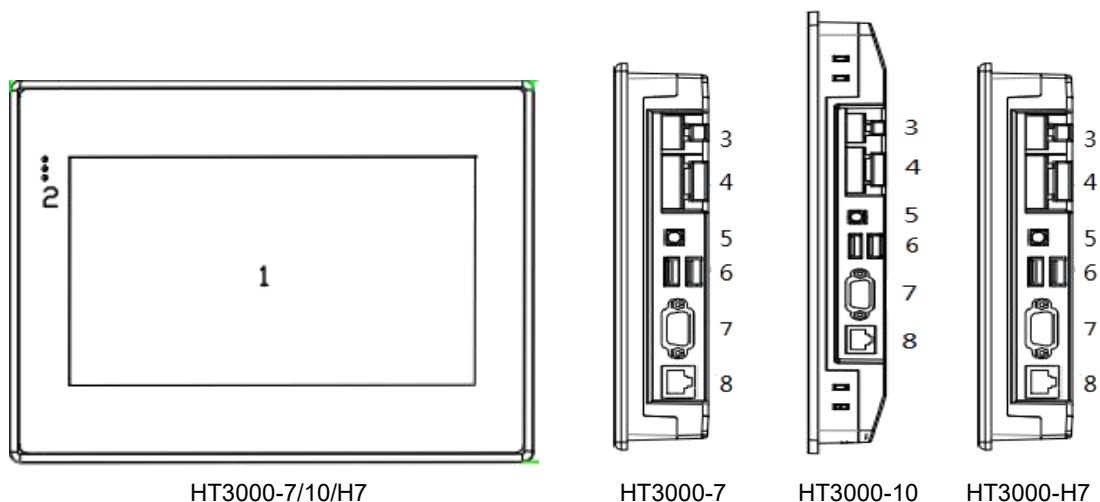

Port diagram and pin definition:

- HT3000-7/10/H7



COM1 Pin definition			
Pin	Definition	Pin	Definition
1	Carrier detect(DCD)	6	Data ready(DSR)
2	Receive data(RXD)	7	Request to send(RTS)
3	Transmit Data (TXD)	8	Clear to send(CTS)
4	Data terminal ready(DTR)	9	Ringing indicating(RI)
5	Signal ground(SG)		

- HT3000-7W/HT3000-10W/HT3000-H7W

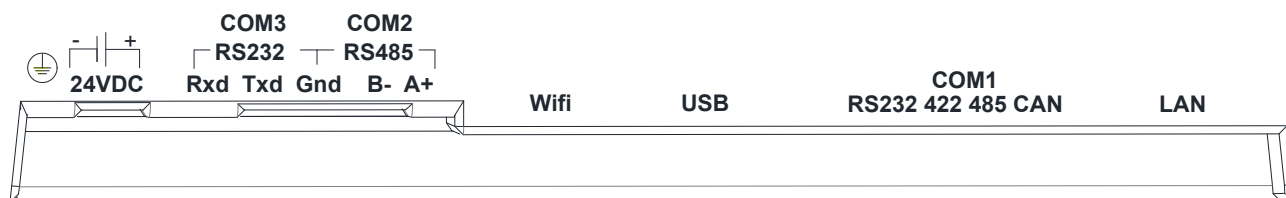

COM1 Pin definition			
Pin	Definition	Pin	Definition
1	Carrier detect(DCD)	6	Data ready(DSR)
2	Receive data(RXD)	7	Request to send(RTS)
3	Transmit Data (TXD)	8	Clear to send(CTS)
4	Data terminal ready(DTR)	9	Ringing indicating(RI)
5	Signal ground(SG)		

- HT3000-7E/HT3000-10E/HT3000-H7E



- HT3000-7EW/HT3000-10EW/HT3000-H7EW



Software Instructions

1. HMI connection settings

HT3000 communicates with the PLC through the RS232 serial port, RS485 serial port or Ethernet port. During the hardware wiring process, the HT3000-10 communicates with the PLC through the RS232 serial port and connects to the static Ethernet network.

a. Notes and hardware installation steps

- Notes

①The installation direction must be in accordance with the provisions of this manual, strictly in accordance with the direction of the terminal wiring, otherwise it will cause product failure or burnout.

②The HMI and other components which are at the bottom must maintain sufficient space to avoid equipment damage caused by poor heat dissipation

- Hardware installation steps

Install the HMI into the cut-out panel and lock the four buckles on the side with the mounting panel.

b. Hardware wiring

- Devices connection with power

HMI and PLC both connect with power.

- Devices connection

HMI's COM-RS232 interface is connected to the PLC's RS232 interface;

c. Network connection

Step 1: Long press the upper right corner of the HMI device to enter the background settings interface.

Step 2: Click [Network] to enter the Ethernet settings interface;

Step 3: Open [Switch] for network;

Step 4: You can select [Static IP] or [DHCP] as needed. When the network type selects [Static IP], you need to set the network

parameters: enter the correct IP address, subnet mask, default gateway and DNS, click [Save] After the verification is passed, the HMI device can connect to the network via Ethernet.

The image shows a network configuration window with two tabs: "Network" (active) and "Wifi". Under the "Network" tab, there is a "Switch:" toggle which is currently turned on. To the right of the toggle is a "Save" button and a small icon of a computer with a green checkmark. Below the toggle, there are two options for "Type": "DHCP" and "Static IP", with "Static IP" being selected. The configuration fields are as follows:

- IP Addr:** 192 . 168 . 70 . 202
- MASK:** 255 . 255 . 0 . 0
- Gateway:** 192 . 168 . 0 . 1
- DNS:** 192 . 168 . 0 . 1

2. Project running

a. Select device models

Step 1: Open HTCloud Designer software and set up a new project;

Step 2: Open [Project configuration] in the project browser, and click [Project properties] to enter the project property configuration interface.

Step 3: Select the device model in the [Layout Info] field, which is consistent with the current device model. In this example, HT3000-10 is taken as an example. Select HT3000-10 and click [OK].

The image shows a "New project" dialog box with the following sections:

- Project information:**
 - Project name: Unnamed project
 - Project description: (empty)
 - Project open password: (empty) Show
 - Run exit password: (empty) Show
 - Project upload password: (empty) Show
- LayoutInfo** (selected tab):
 - Runtime platform: HT3000-10 (selected)
 - Angle(°): 0

Buttons: OK, Cancel

b. Download project

Project Step 1: Enter the device manager, you can choose to use the local manager or cloud manager;

Step 2: Click [Download project] to enter the project download confirmation interface;

Step 3: In the confirmation download interface, you can choose whether to reserve the history and alarm records, whether to reserve the formula and whether to package the font download. After the setting completed, click [OK];

Step 4: Wait for the pop-up prompt "Download successful!" and click [OK] to run the project on the device.

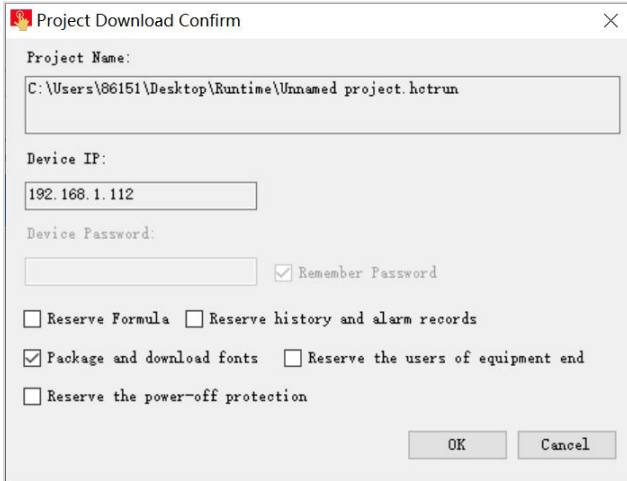

c. Run project

After the project successfully downloaded, wait for the HMI to restart, and after restart successfully, the HMI will automatically open the project startup screen, and users can use the project as needed.

3. HTCloud manager

Open the HTCloud Designer software in computer, click the device manager icon of menu; or click the [project], open the [HTCloud Designer] installation document ,open the [HTCloud Manager] and enter device manager. Support to use the local manager and cloud manager effective control HMI.

a. Enter device manager interface

● Local manger

Enter device manager,click[local manager], set up IP address up on device and select device, click [mange] and enter currently device manger, you can operate the current device as shown below

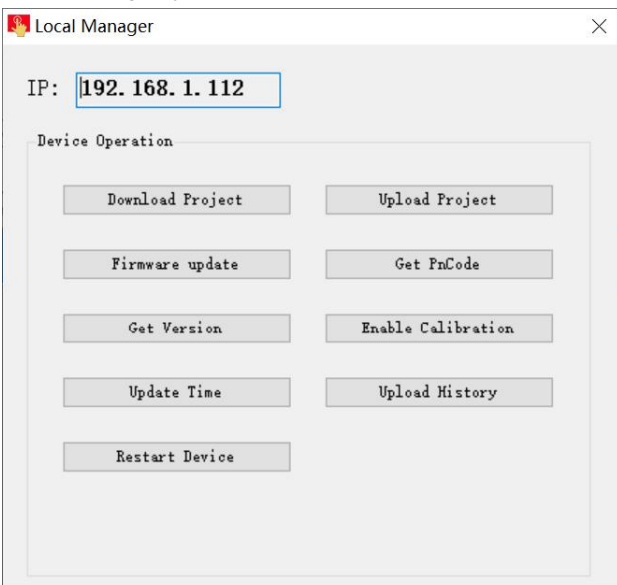

- **Could manager**

Step 1: enter device manager, click [cloud manager], optional log in with mobile phone or email. PS: device administrator and machine owner can manage current device through cloud manager, common user don' t have administrative authority.

Step 2: user input correct account and password, click [sign in] enter device manager, choice[manage]. enter current device manager, can operating current device, the following diagram:

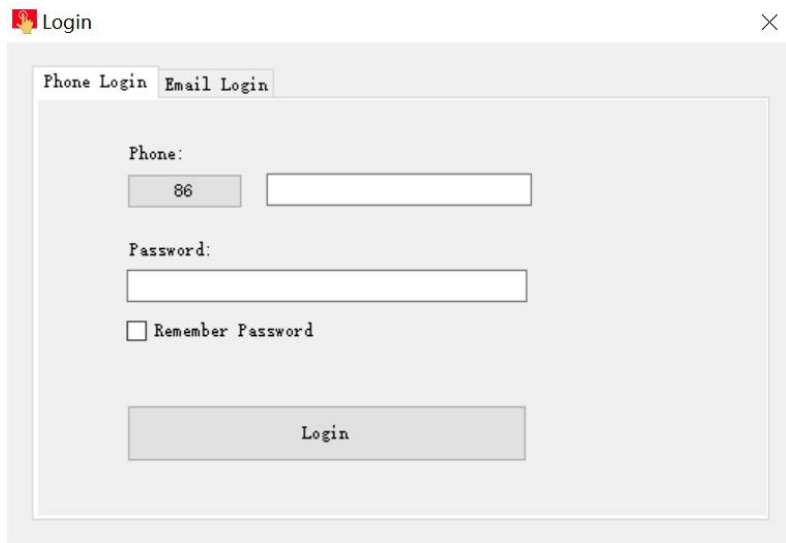

- b. **Excute device management**

- **Download project**

Step 1: click [download project], enter project download confirm;

Step 2: In the confirmation download interface can choose whether to keep the history and alarm records, whether to keep the recipe, and whether to download the packaged fonts. After the setting are complete, click [OK];

Step 3: Wait for the pop-up prompt "Download successful!", click [OK], running the project in device.

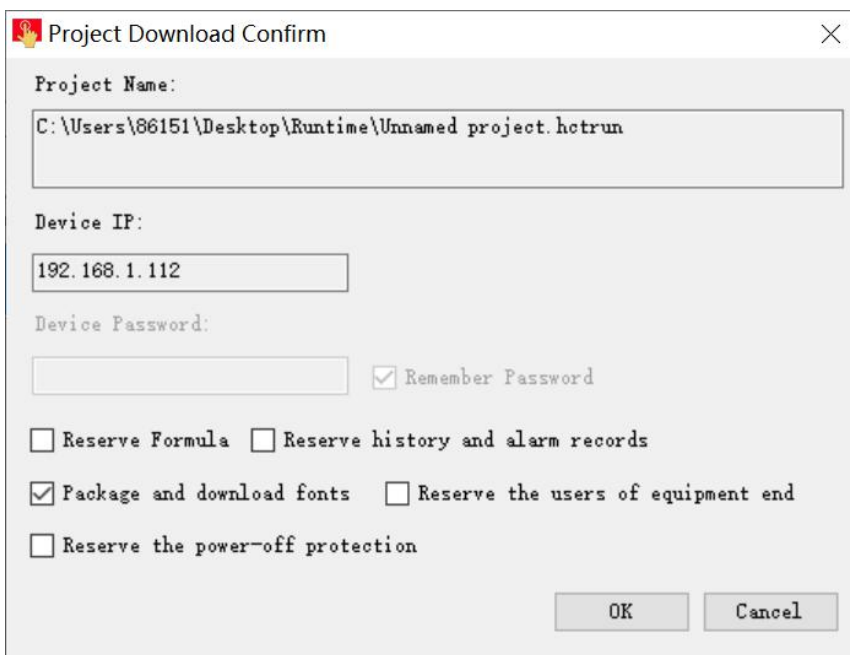

- **Upload project**

Step 1: click [upload project], choice the upload path and project name, click save;

Step 2: enter project upload and confirm interface, if project set up upload password, need to input the upload in [project

upload password]; if the project don't have to set up the upload password, no pass word is required here;
Step 3: click [upload], wait for the pop-up prompt " upload successful!", click [OK], running the project of device in PC.

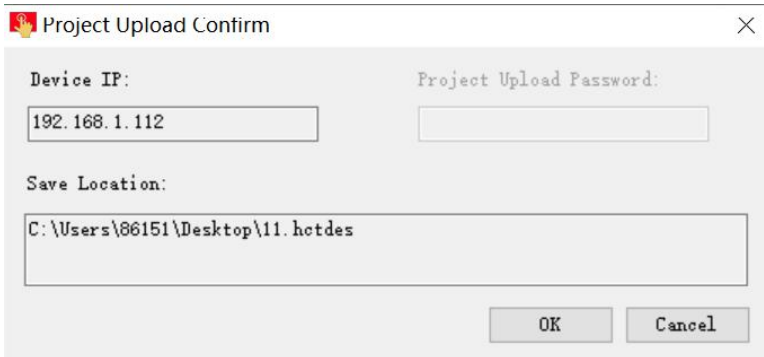

- Firmware update

Step 1: click [Firmware update],choice firm package, click [open], The latest firmware update package can be get from HNC
Step 2: enter offline update confirm interface, click [update]
Step 3:waiting for update to complete, pop-up prompt " update success", click [OK].

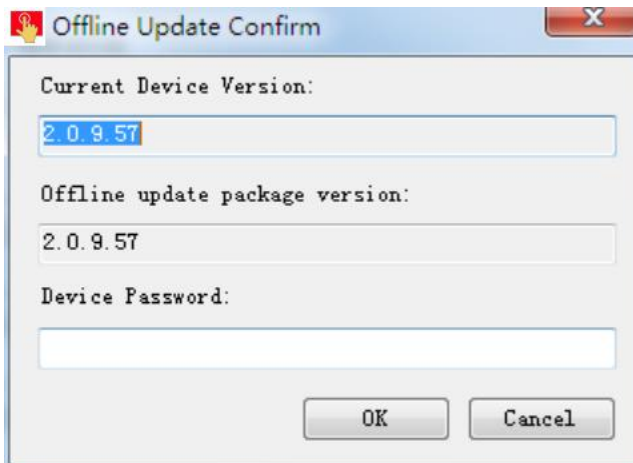

- Start calibration

Click [start calibration],the device enter the calibration interface, press the calibration mark 1above the screen for long time, and enter next calibration site, calibration the device touch the screen in order of "left, right, up, down, mid"

- Update device-time

Click [update device time], can to update system time of device. When update to complete, you can device-time, device -time and system time of PC are same.

- Get the PN code

Click [get PN code], can to view the current PN code of device.

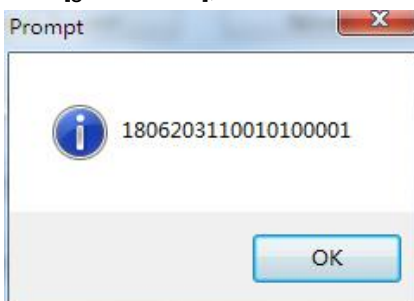

- Check the device version

Click [Get version], can to view the current version information of software and hardware of device.



- Upload the history record

Click [upload the history record],enter the upload interface of history record.

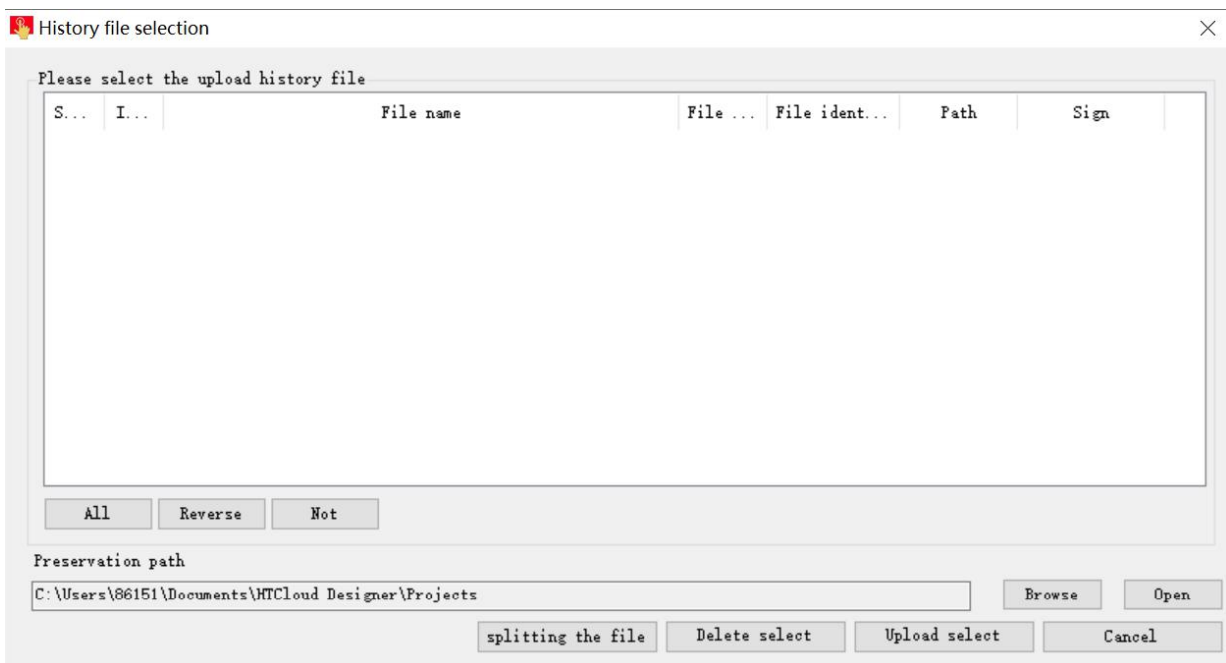

① split history file

Step 1: click [start split file], you can split historical files for the recent period of time.

Step 2: waiting split the historical record to complete, pop-up prompt [split success], click [OK], historical file list will add current split historical files.

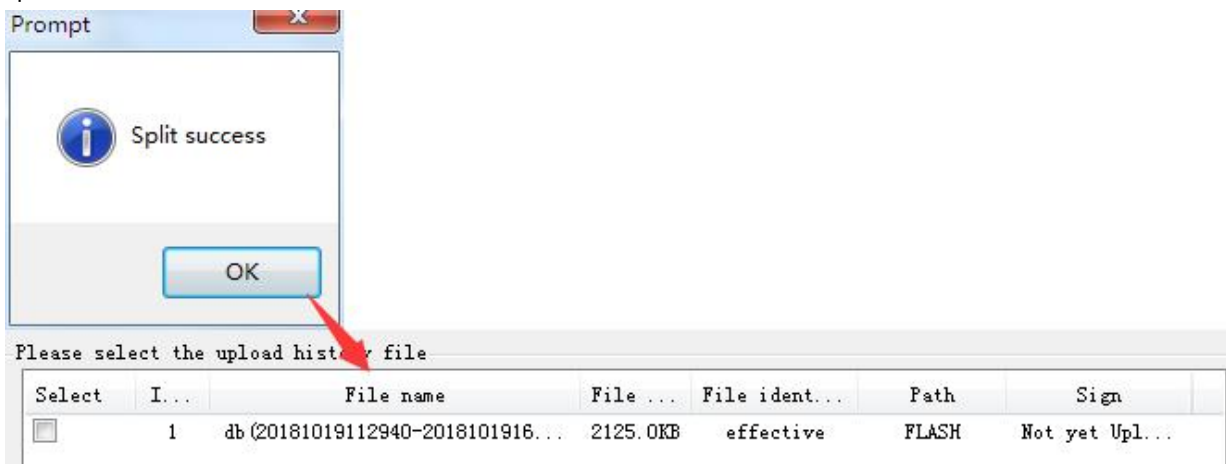

②upload historical file

Step 1: select historical file in historical file list, input historical file storage. Path, click [upload select file];

Step 2: waiting for upload the historical file to complete, pop-up prompt " upload the historical record success", click [OK].

When upload to complete, current historical file will remark "have uploaded".

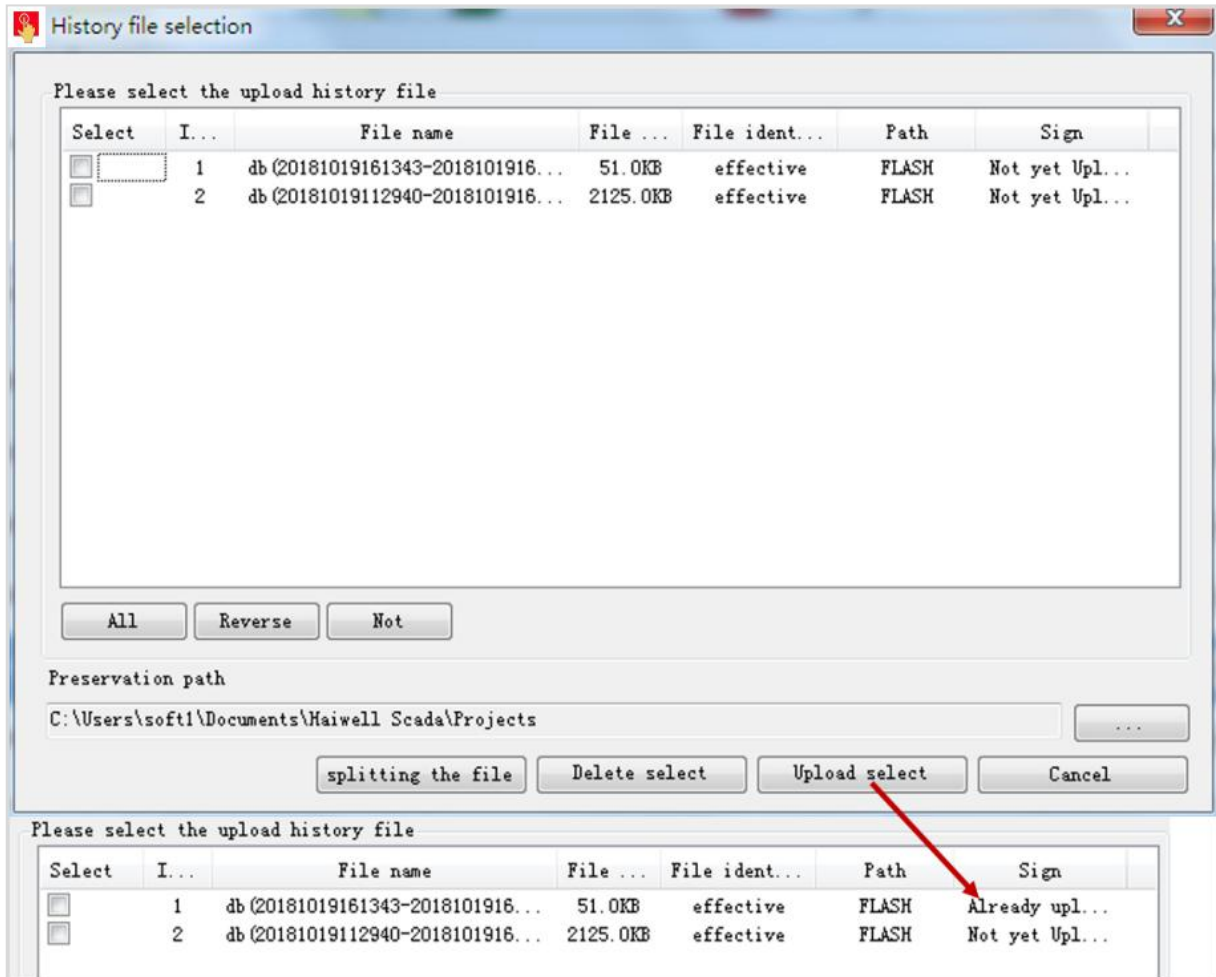

③ Delete history file

Step 1: Select the history file in the history file list and click [Delete Select File]

Step 2: Pop up the Confirm Delete File prompt box and click [Yes];

Step 3: Wait for the history file to be deleted successfully. The "Delete Successful!" prompt box will pop up, click [OK].

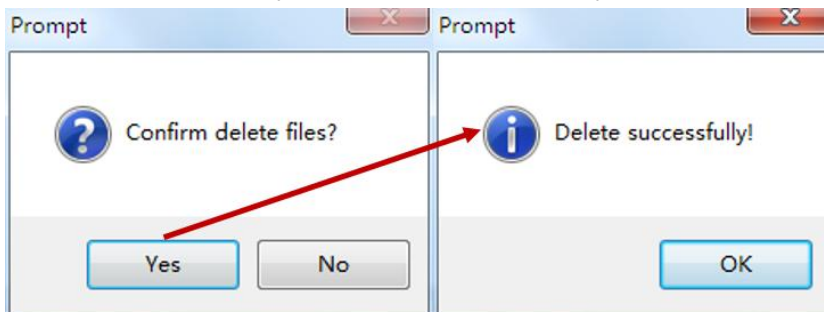

● Restart the device

Step 1: Click [Restart Device], pop-up confirmation restart prompt box click [Yes];

Step 2: Wait for the device to restart. After the restart is successful, the "Device Restart Successful" prompt box is displayed, and click [OK].

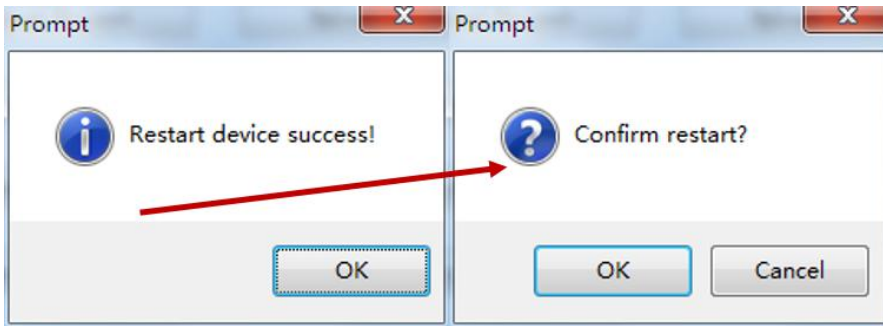

4. Background settings

Long press the upper right corner of the HMI device to enter the background settings interface, or access the HMI through a browser, enter IP / setting to enter the background settings interface

a. Project Settings

- Connect Network Engineering

Enter the HT3000-10 background settings interface, click [Project], click [Connect Remote], enter the IP of the HMI in the LAN to be connected to for remote access between HMIs

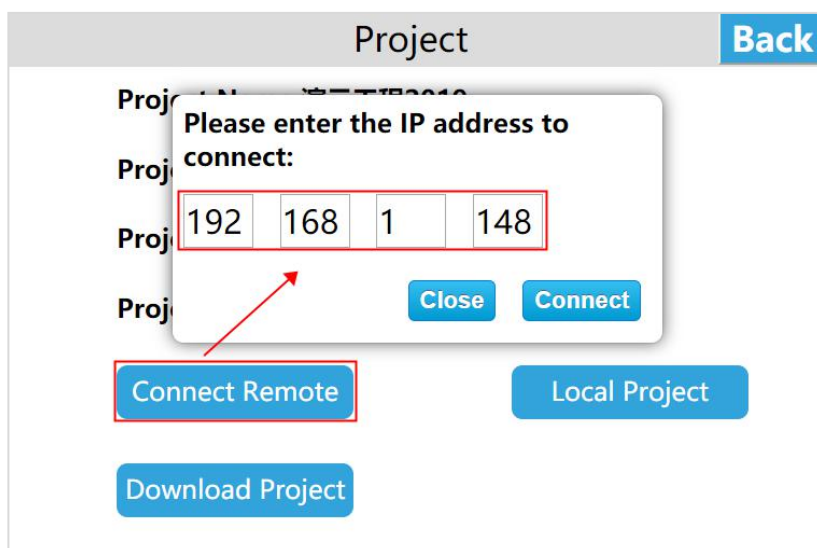
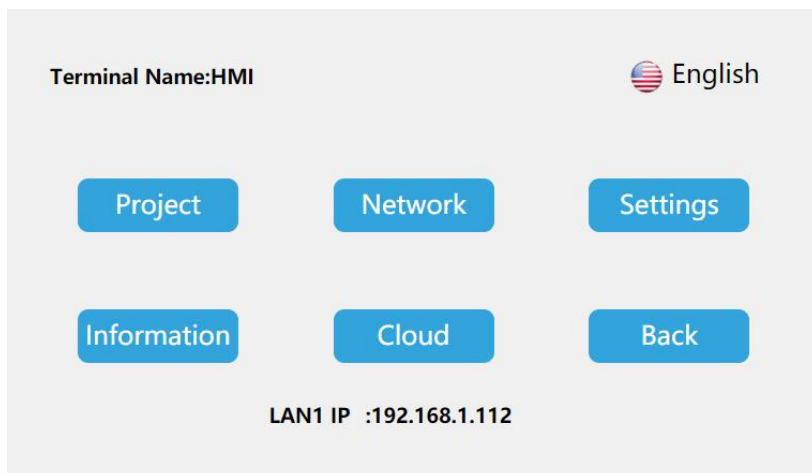

- Download project

Step 1: Create a project, click [Project] in the HTCloud Designer menu bar, expand the tab, and click [Generate U Disk or SD Card run file];

Step 2: Enter the compilation interface, set the appropriate output path after compilation, click [Save];

Step 3: After the running file is saved successfully, the system will pop up a prompt box of saving successfully, click [OK].

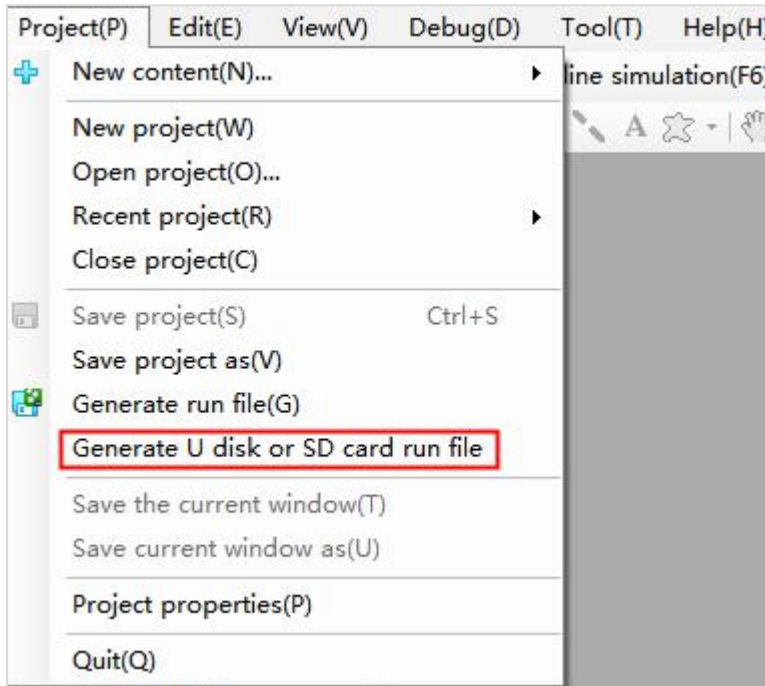

Download project

■ U dist download project

Step 1: Enter the HT3000-10 background settings interface, click [Project] to enter the project settings interface;

Step 2: Click [Download Project] to enter the project download interface;

Step 3: Insert the U disk, select [USB]; select the project according to the requirements, click [OK]. and the HT3000-10 device will automatically restart after the successful download.

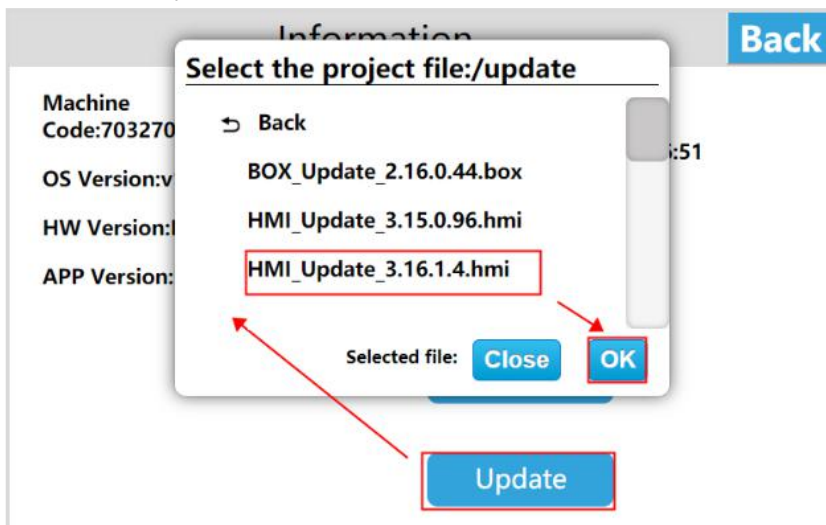

■ SD card download project

Step 1: Enter the HT3000-10 background settings interface and click [Project];

Step 2: Enter the project settings interface, click [Download Project] to enter the project download interface;

Step 3: Insert the U disk, select [SD], select the project according to the requirements, click [OK]. and the HT3000-10 device will automatically restart after the successful download.

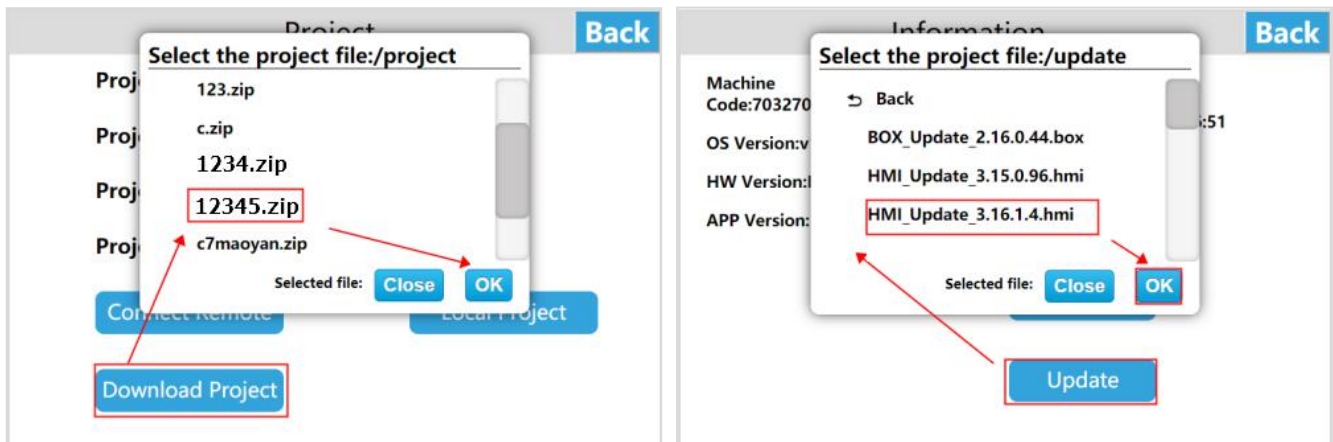

b. Network Settings

• Ethernet connection

Enter the HT3000-10 background settings interface, click [Network], enter the Ethernet settings interface, open the [Switch], the network type includes DHCP and Static IP.

① Dynamic IP

Connect the network cable, select [DHCP] for the network type, and click [Save], the device will automatically obtain the IP.

② Static IP

Connect the network cable, select [Static IP] for the network type, enter the correct IP address, subnet mask, default gateway, and DNS, and click [Save]. After verification, the device can be connected to the network via Ethernet.

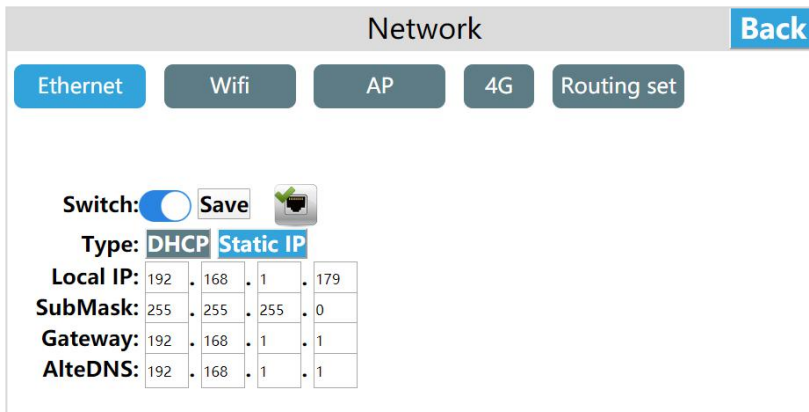

• WI-FI settings

Click [WI-FI] to enter the WI-FI settings interface, which support connecting to the network via WI-FI. Enter the WI-FI settings interface, turn on the WI-FI switch, select the target WI-FI account, enter the correct WI-FI password, and connect to the WI-FI network after verification.

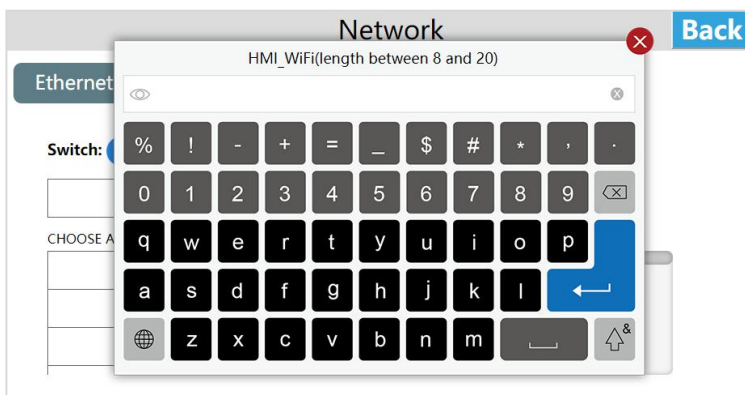

After the connection is successful, display the green tick "✓".

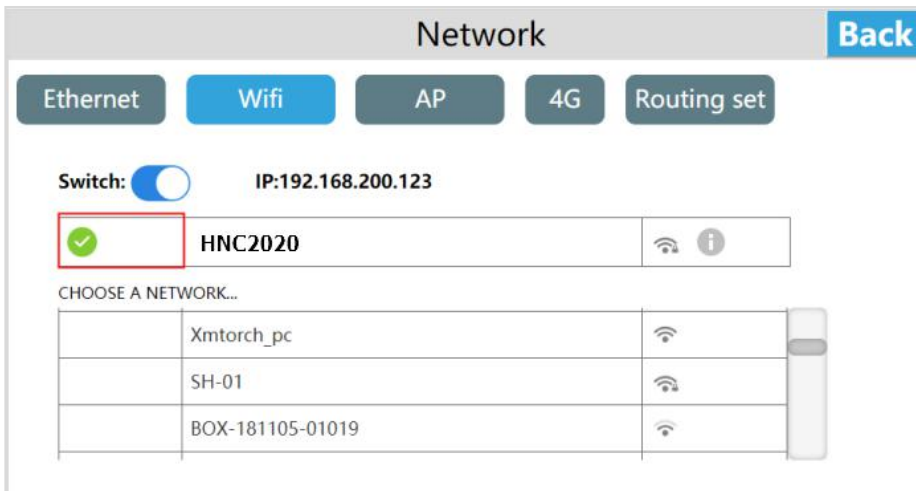

After the connection is successful, you can see the gray 'i' icon, click the gray 'i' icon can set the IP address, subnet mask, default gateway, DNS.

After setting, click [Save] to set WI-FI IP address information.

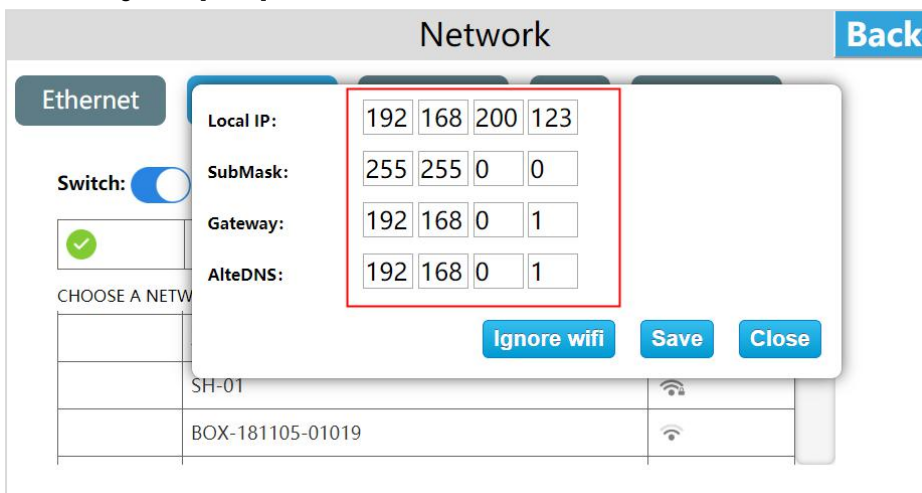

Click the gray 'i' icon and then click "Ignore WI-FI" to disconnect the WI-FI connection. If you want to use the WI-FI, you need to re-enter the password to connect.

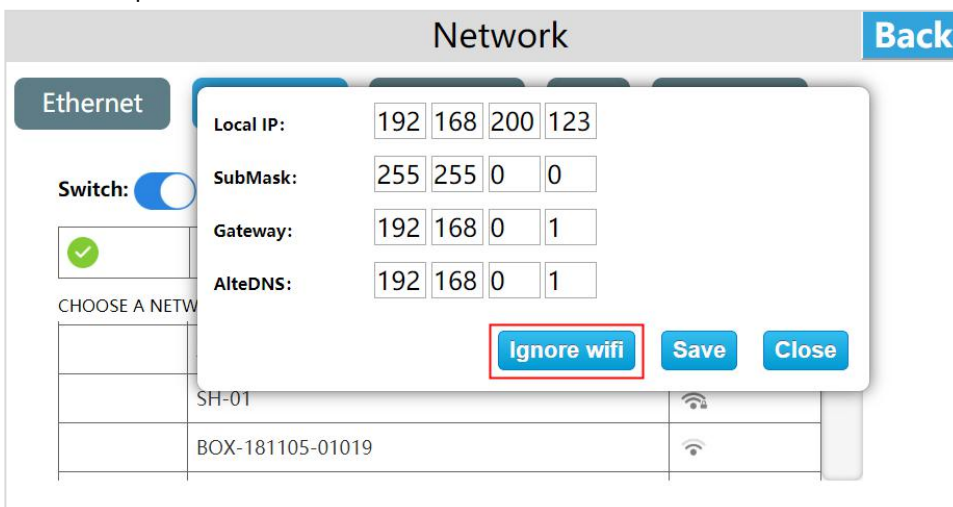

Click the gray i icon and then click [Close] to close the window.

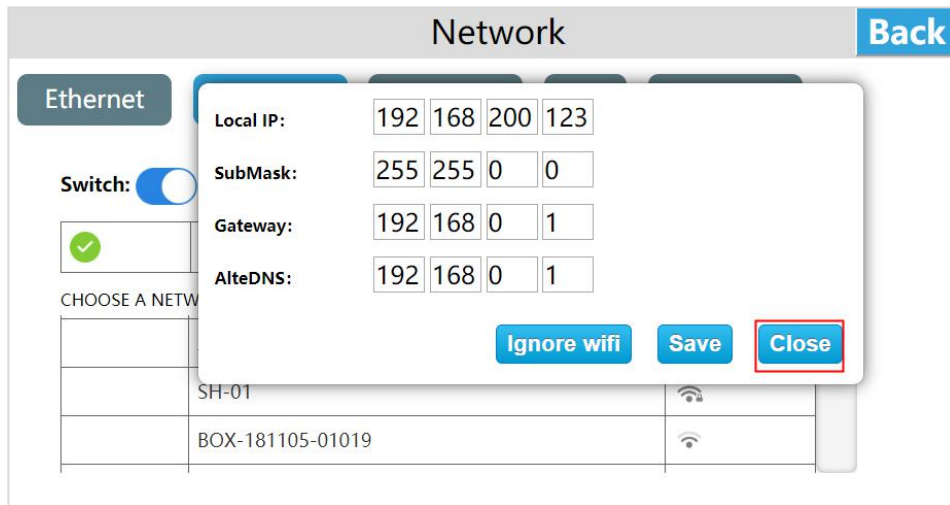

- Personal hot spot

Click [AP] to enter the personal hot spot interface, the HMI built-in network card can also be shared to share WI-FI hot spots for other users. Turn on the personal hot spot switch and set the hot spot name and password to share the WI-FI hot spot for other users.

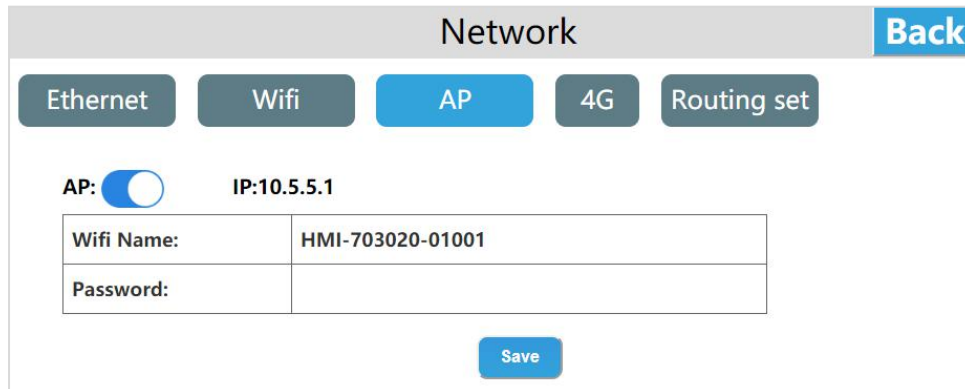

Set the hot spot name, click "hot spot name", a hot spot name input box pops up.

Enter the hot spot name, click [Enter], and click [Save] to save the added hot spot name information.

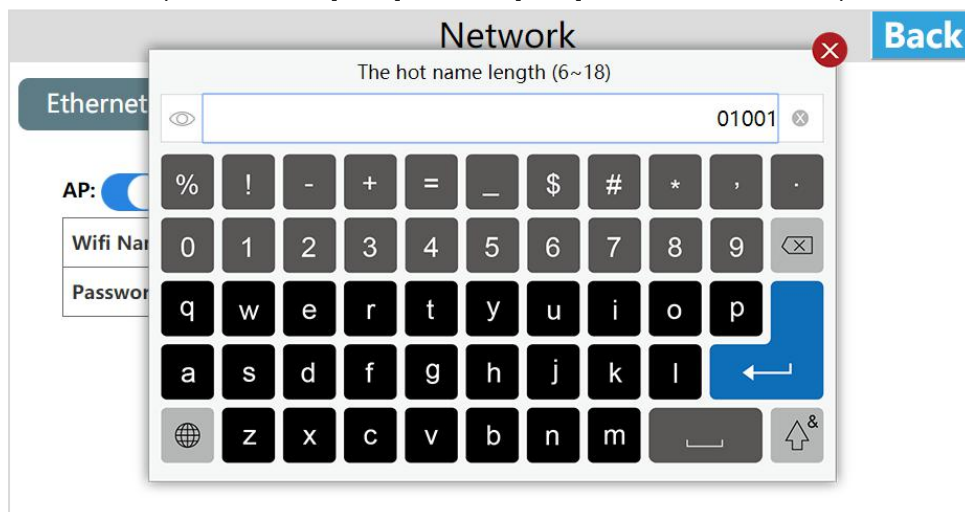

Set password, click "Password", a password input box pops up, click on the upper left corner of the input box  to switch the plaintext ciphertext of the password.
 Enter the password, click [Enter], and click [Save] to save the added password information.
 The factory default WI-FI password is empty.

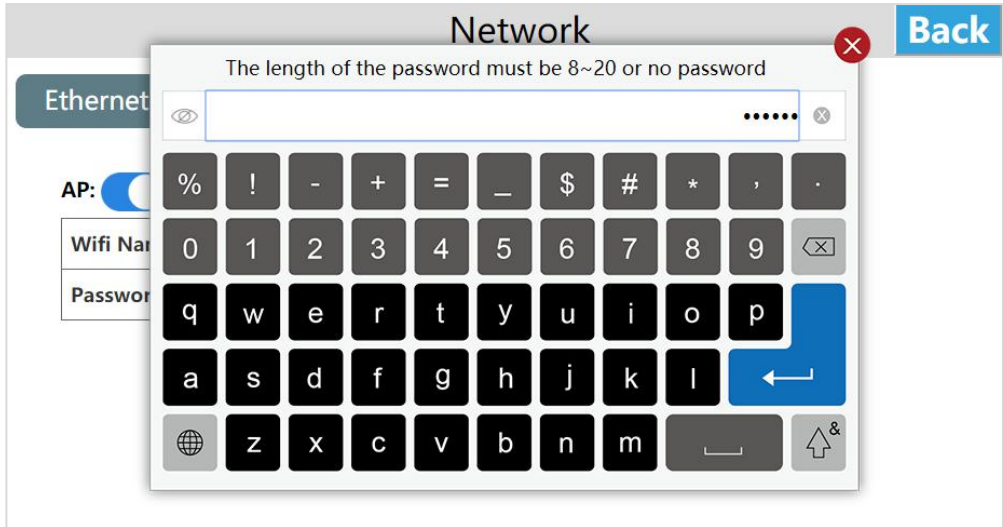

Note: The length of the hot spot name is 6 to 18 bits, and the password can be empty or set to 8 to 20 bits.when it exceeds the range,the entered hot spot name and password will not be displayed in the corresponding location and a prompt will pop up.

● [Network configuration model](#)

The new series of HMI has the following 4 different network configuration models (take HT3000-7 as an example).

➤ [Standard \(HT3000-7\)](#)

The HMI standard version only has Ethernet and does not include WI-FI / 4G / hot spot / routing modules,and the network onl provide y by the network cable

➤ [With WI-FI \(HT3000-7W\)](#)

HMI with WI-FI version only includes Ethernet and WI-FI, without 4G / hot spot / routing module, and the network is provided by network cable / WI-FI.

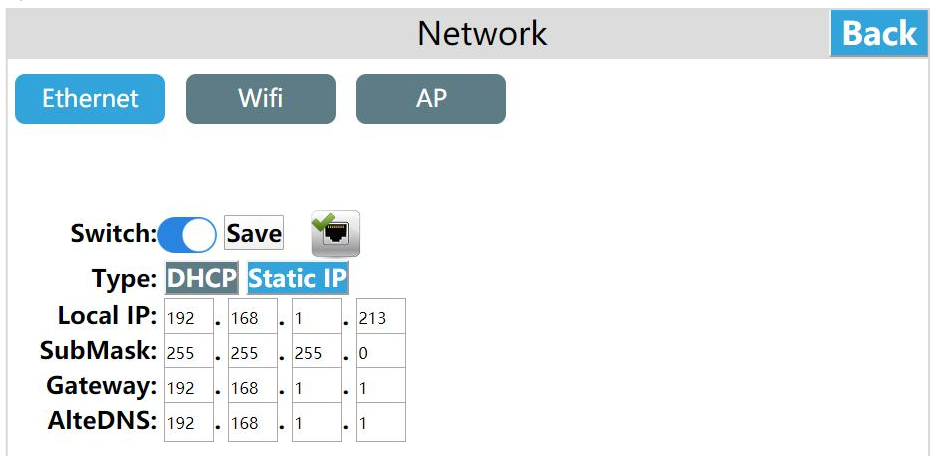

➤ [With 4G \(HT3000-7G\)](#)

The HMI with WI-FI version includes Ethernet, 4G ,and routing modules, without WI-FI / hot spots, and the network is provided by the network cable / 4G.

The routing modes include: :close routing /4G client mode. The specific use of each routing mode will be explained below.

➤ [With 4G with WI-FI \(HT3000-7GW\)](#)

The HMI with 4G and WI-FI version includes Ethernet / WI-FI / 4G / routing module, and the network is provided by Ethernet / WI-FI / 4G.

The routing modes include:close routing / AP point mode / 4G routing mode / client mode / The repeater mode / 4G client mode, the specific use of each routing mode will be described below.

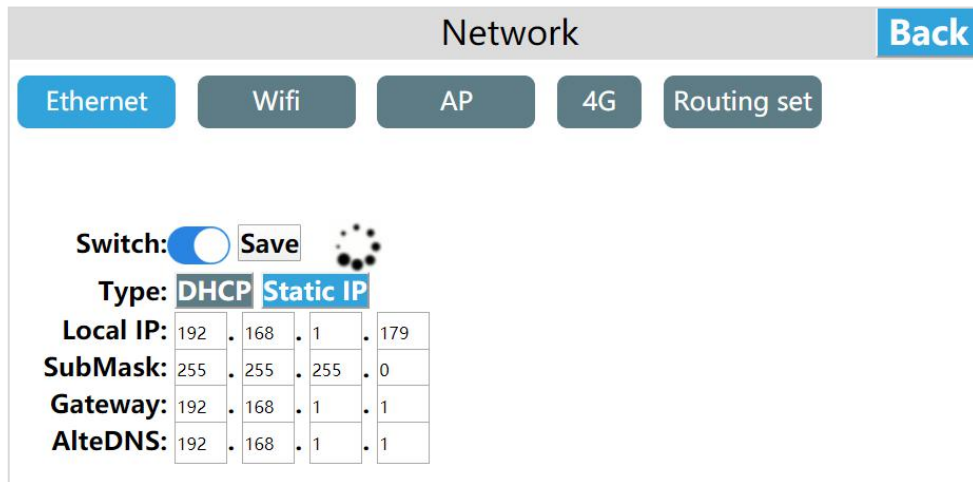

● Routing configuration

The routing modes include:close routing / AP point mode / 4G routing mode / The repeater mode / client mode/ 4G client mode, the default is "Close routing"

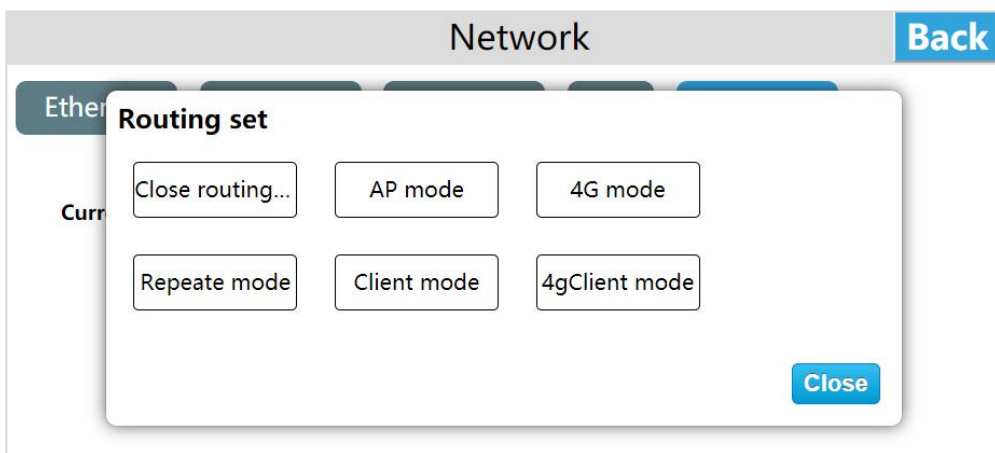

Comparison of various routing modes and network types:

	Close routing (Routing switch)	AP MODE	4G routing mode	Repeated mode	Client mode	4G client mode
Ethernet	LAN / Internet	LAN / Internet	LAN	LAN	unsupported	unsupported
WI-FI	LAN / Internet	unsupported	unsupported	Connect to the Internet	Connect to the Internet	unsupported
Hotpot	LAN	LAN / Internet	LAN / Outer net	LAN / Internet	unsupported	unsupported
4G	Outer net	unsupported	Internet	unsupported	unsupported	Outer net
Network provided	Ethernet/WI-FI/4G	Ethernet	4G	WI-FI	WI-FI	4G

Close routing mode

Enter the HMI background settings interface, click [Network], enter the route configuration interface, click "Settings", click "Close routing", a prompt "This mode will will close the route, confirm the routing mode is closed" Click "OK", it is set to close routing

"Close routing" mode, only turn off the Ethernet, WI-FI, 4G routing function. The hot spots open in this mode only support LAN networks, and do not support Internet access. The function settings of Ethernet, WIIF and 4G remain unchanged.

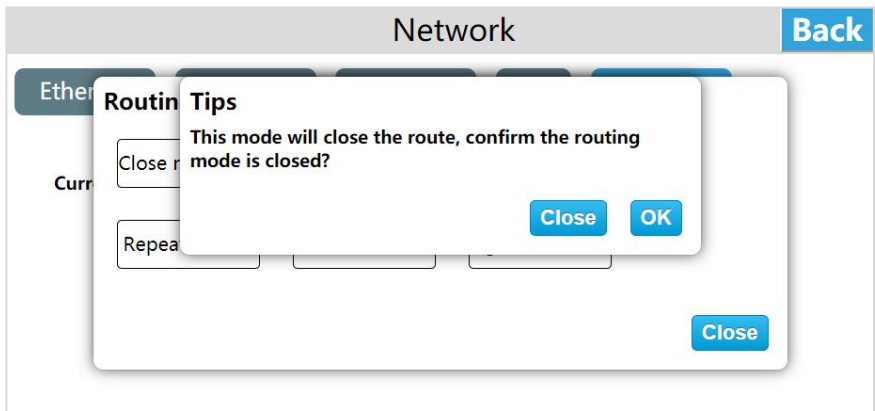

AP mode

Enter the HMI background settings interface, click [Network], enter the routing configuration interface, click "Settings", click "AP Mode", a prompt "This mode will turn off 4G and WI-FI, are you sure to switch to this mode?", Click "OK" to set to wireless access point mode.

In the "AP" mode, only the wired network provides the network, and Other devices can access LAN and internet by connecting to the personal hot spot of the device.

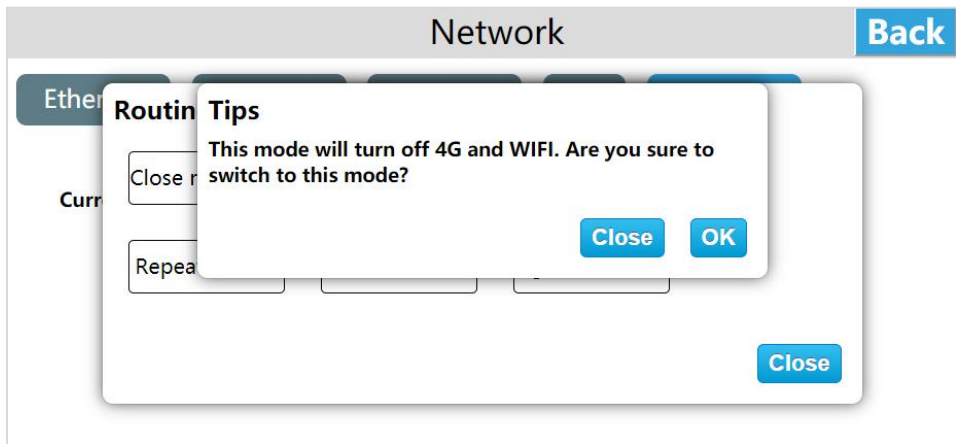

4G routing mode

Enter the HMI background settings interface, click [Network], enter the routing configuration interface, click "Settings", click "4G Routing Mode", a prompt "Will this turn off WI-FI,confirm switching to this mode ?", click "ok" to set the 4G routing mode.

In "4G routing" mode, only 4G provides the network to the device, and other devices can connect to the local area network and external network by connecting the personal hot spot of the device. The wired network in this mode only supports LAN networks.

In the "4G routing" mode, only 4G provides the network to the device, and other devices can connect to the LAN and internet through the personal hot spot of the device. Wired networks in this mode only support LAN networks.

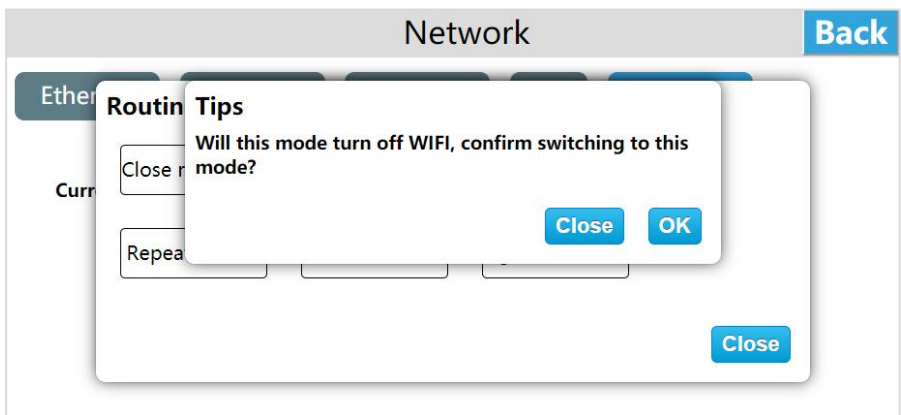

Repeater mode

Enter the HMI background settings interface, click [Network], enter the routing configuration interface, click "Settings", click "Repeater", a tips shown "This mode will turn off 4G, confirm switching to this mode?" , Click "OK" , set to repeater mode.

In "Repeater" mode, only connected hot spots of WI-FI provide the network. First, connect a hot spot that can be connected to the Internet, and then provide network to other devices through the personal hot spot of this device, supporting both local area network and extra-net. The wired network in this mode only supports LAN networks.

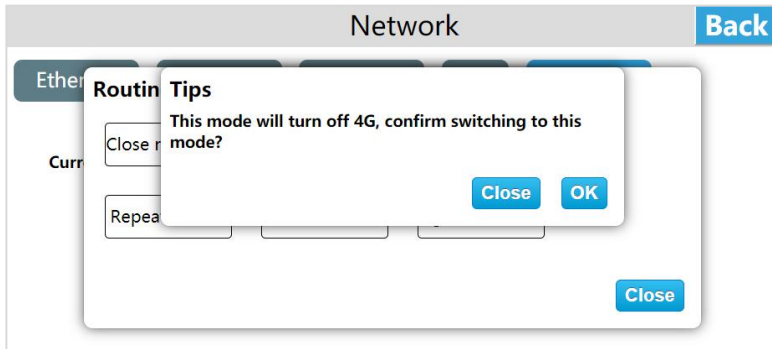

Client mode

Enter the HMI background settings interface, click [Network], enter the routing configuration interface, click "Settings", click "Client mode", a tips shown "This mode will turn off personal hot spots and 4G, confirm switching to this mode?", Click "OK" to set the client mode, The client mode will fix the IP to 192.168.255.1.

In the "Client" mode, the network is provided by the hot spot connected by WI-FI. At this time, the HMI is equivalent to a router. The HMI is connected to the wired network, and then connected to the device through the wire to provide the network to the device. In this mode, personal hot spot function is not supported.

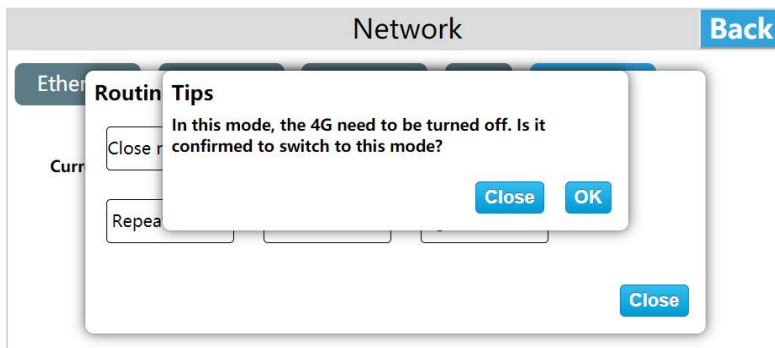

4G client mode

Enter the HMI background settings interface, click [Network], enter the routing configuration interface, click "Settings", click "4G Client Mode", a tips shown "This mode will turn off personal hot spots and WI-FI, confirm switching to this mode?" , Click "OK" to set to 4G client mode.

In the "4G client" mode, 4G provides the network. The HMI at this time is equivalent to a router. The HMI connects to the wired network, and then connects to the device through the wire to provide the network to the device. In this mode, personal hot spot function is not supported.

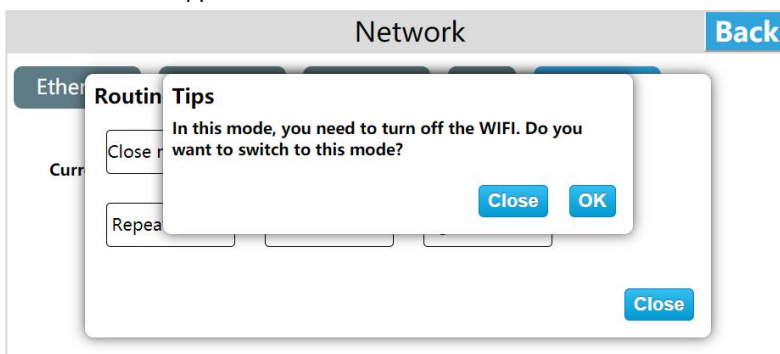

c. Settings

● Settings

① Set the terminal name

Enter the HMI background settings interface, click [Settings], in the [Settings] interface, you can see the [terminal name], click [Set], enter the new terminal name, click Enter on the keyboard Name. Terminal name: device name, terminal code: device number.

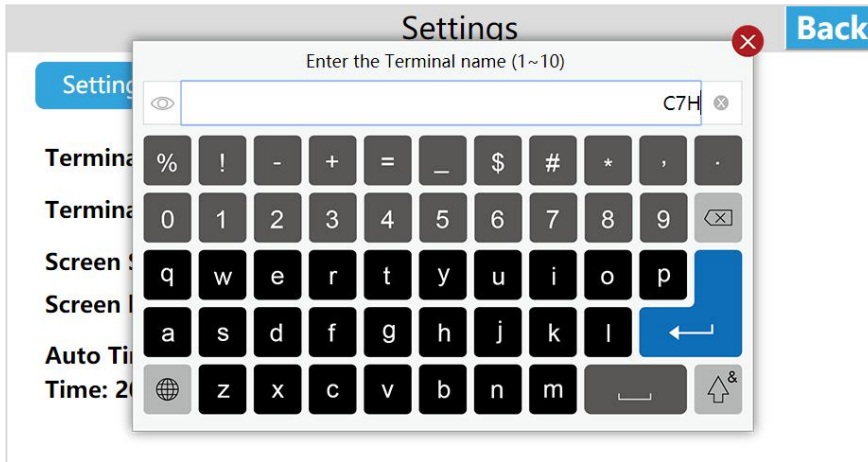

Note: The length of the terminal name is 1 ~ 10 characters.

② Set terminal code

Enter the HMI background settings interface, click [Settings], in the [Settings] interface, you can see [Terminal code], click [Set], enter the new terminal code, and click Enter on the keyboard.

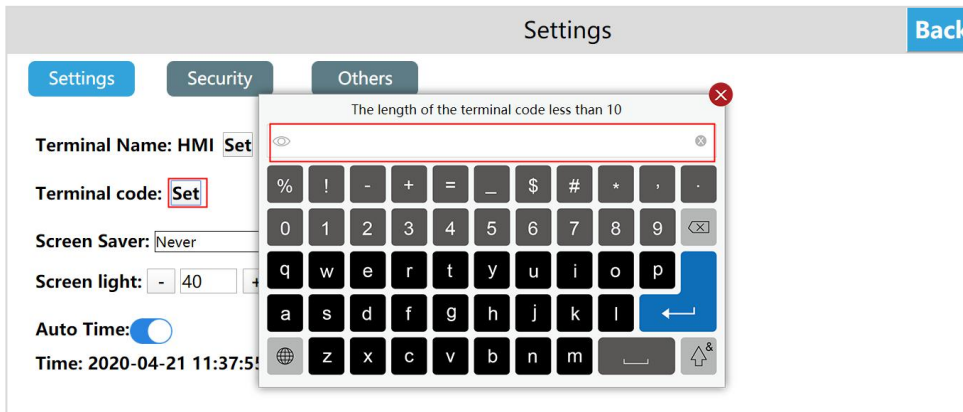

③ Set buzzer switch

Enter the HMI background settings interface, click [Settings], in the [Settings] interface, you can see [Beep], turn on [Beep], when the user clicks the button, the buzzer will respond sound. Conversely, when the user clicks the button, there is no sound.

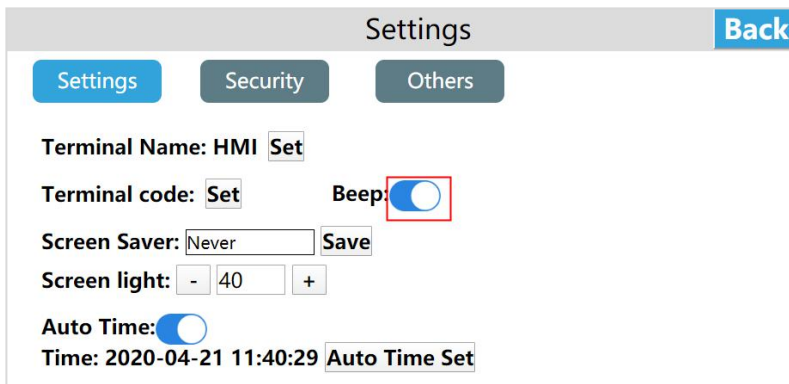

④ Set the network time

Enter the HMI background settings interface, click [Settings], open the [Auto time] in the [Settings] interface, and then click the [Auto time set], the current time will automatically correspond to the network time.

Enter the HMI background settings interface, click [Settings], turn off the [Auto time] on the [Settings] interface, and then click [Modify] change time, you can manually enter to set the time. After the input is complete, click OK; if click Cancel means not to save it.

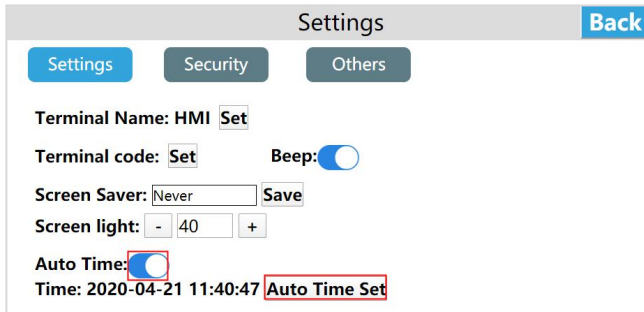

● Security settings

① Download project password

Enter the HMI background settings interface, click [Settings], open the [Download project password] function in the [Security] interface, set the project download password, after the setting is successful, the user needs to verify the password to download the project and update the firmware, otherwise it cannot be executed related operations.

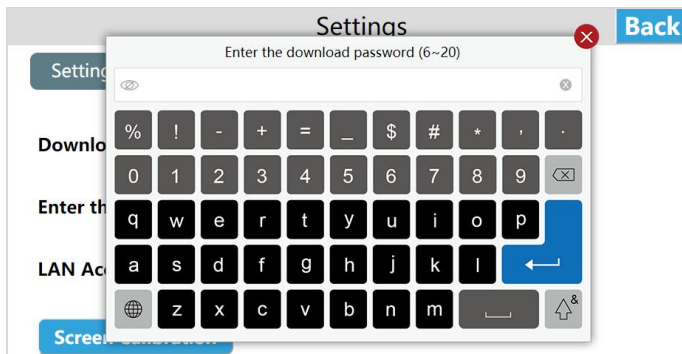

② Enter background password

Adding password verification into the background can avoid potential security risks and economic losses caused by misoperation of unrelated personnel. The specific operations are as follows:

Step 1: Enter the HMI background settings interface, click [Settings];

Step 2: Open the [Enter the set interface password] function on the [Security] interface;

Step 3: Set the password for entering the background. After the setting is successful, the user needs to verify the password when entering the background settings.

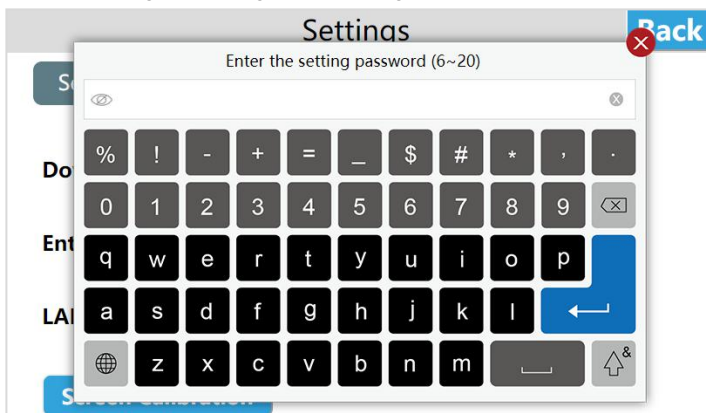

③ LAN access

Enter the HMI background settings interface, click [Settings], switch to the [Security] interface, and enable LAN access by default. The user can click [Set password], enter the password to be set, click Enter, then enter the password again, and click Enter to save the LAN access password. To access the device via LAN / mobile APP / cloud website / TVBOX etc, the user must enter the correct LAN password.

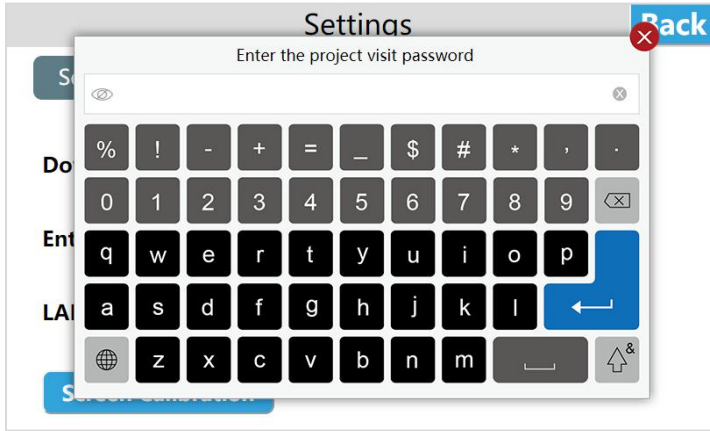

Click [Empty password], a pop-up "set up success", that is to clear the previous LAN password, users can access the HMI through the LAN (without entering any password).



④ Enable screen calibration

Click [Screen calibration], pop up [Enabling calibration will restart the device, whether to restart the calibration?], click OK to perform touch screen calibration.

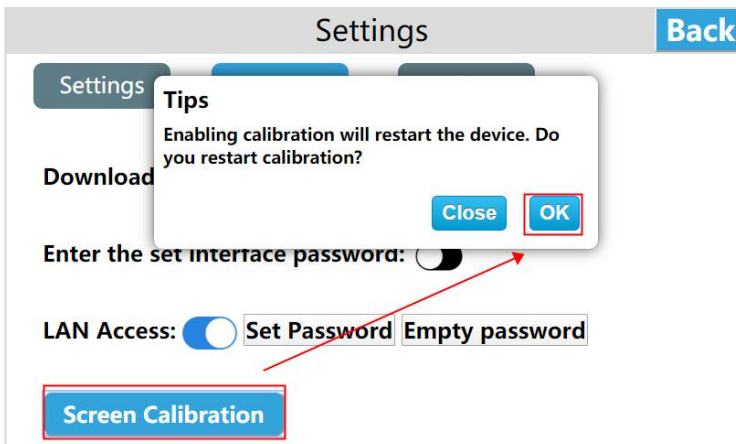

● Others

① Set the frequency of cloud online detection

Enter the HMI background settings interface, click [Settings], switch to the [Others] interface, click Settings on [Cloud On-line Detection], select the cloud online detection frequency which we need.



② Set the current cloud server

Enter the HMI background settings interface, click [Settings], switch to [Others] interface, click [Set] on "Now cloud server", select the cloud server address we need, then the current cloud server is displayed as selected server address. Click [Auto] to automatically select a relatively close cloud server address based on the IP address. Click [Close] to close the window.

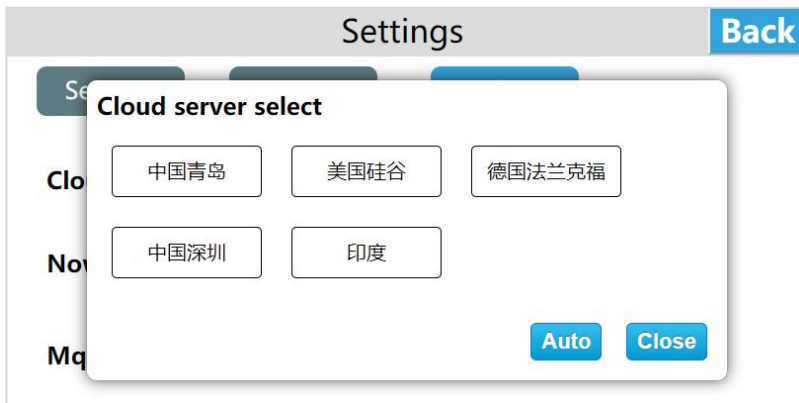

③ MQTT Agency

The firmware version 3.16.0.20/2.16.0.20 and later versions add the MQTT agency function. Click on the "MQTT Agency" to turn on or off the MQTT agency. Turning on the MQTT agent means to use the HMI as a small MQTT server with the server address either Ethernet or WI-FI IP address from the device, please refer to the MQTT user manual. The MQTT agency function is turned off by default. It will continue to be turned on after enabling until manually turned off.

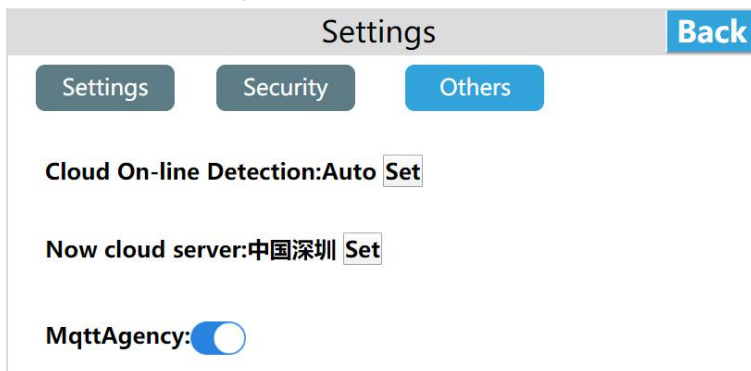

● System Information

① Reboot

The user enters the HMI background settings interface, click [Information], select [Reboot], then can restart the HMI device; also can restart the device through the device manager, the operation method can refer to "Device Manager-Restart Device" Instructions for use.

Related topic: How to restart the HMI device through the device manager?

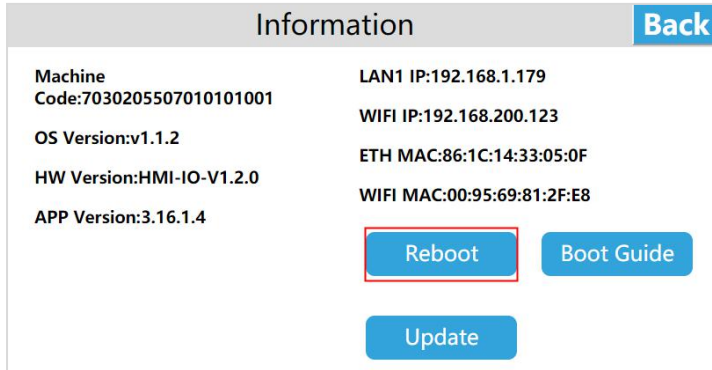

② Firmware update

U disk update firmware

Enter the HMI background settings, click [Information], select [Update], enter the firmware upgrade interface, select [USB], then select the appropriate firmware update package, and click [OK] to upgrade the firmware. After the upgrade is successful, the device will restart.



SD card update firmware

Enter the HMI background settings, click [Information], select [Update], enter the firmware update interface, select [SD], select the appropriate firmware update package, and click [OK] to update the firmware. After the update is successful, the device will restart.

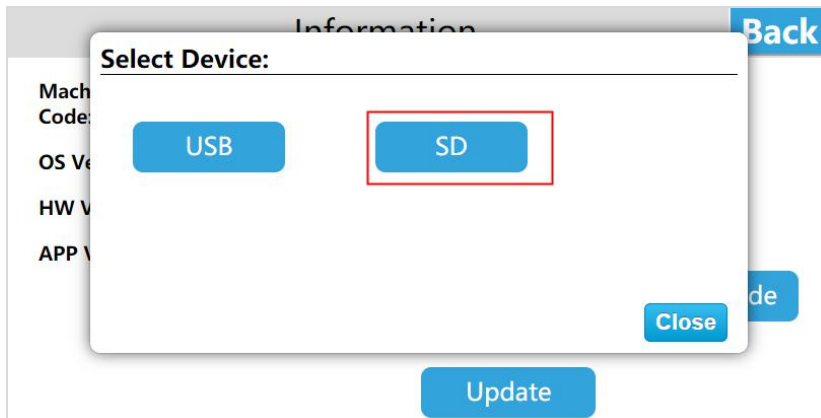

● Cloud settings

Binding device

Enter the HMI background settings interface, click [Cloud], open the [Cloud Switch], and pop up the QR code and machine code.



Log in to the cloud APP on your mobile phone, enter the [Device] interface, click the button  in the upper left corner of the main interface, scan the QR code to add the device. A prompt box for confirming the binding pops up on the device, click [OK], the device is added successfully, and the user can remotely access the device.

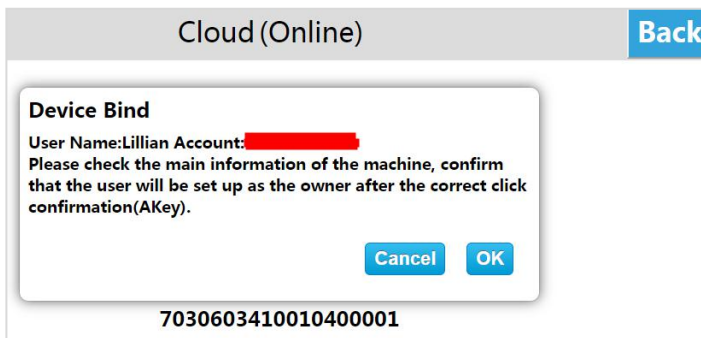

Remote control

Enter the APP on mobile phone and enter the device; click [Access] to access the device. If the current project allows remote operation, the user can remotely control the device through the mobile phone.

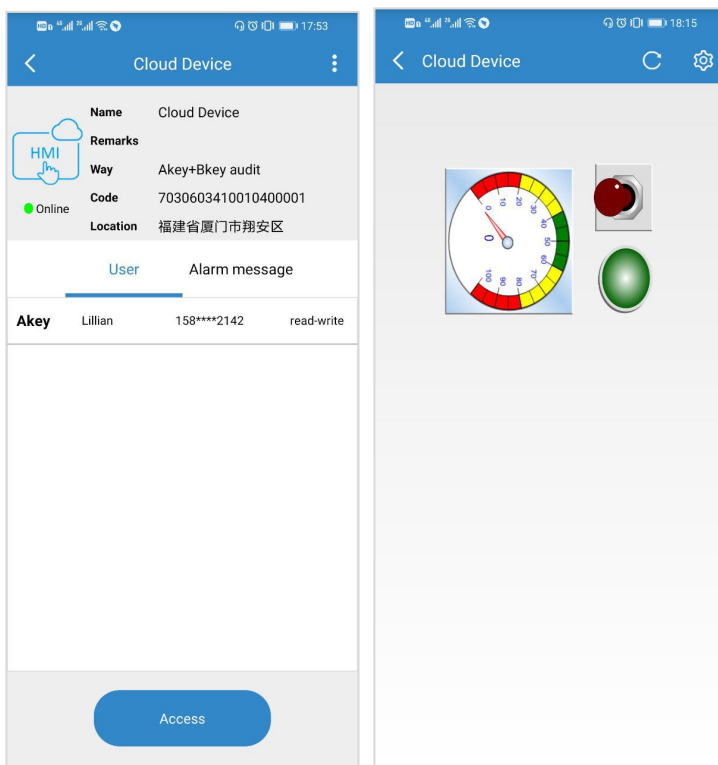

- Multi-language settings

Enter the HMI background settings interface, click the language settings button at the top right of the screen, you can switch the system language, the device supports two languages: simplified Chinese and English.

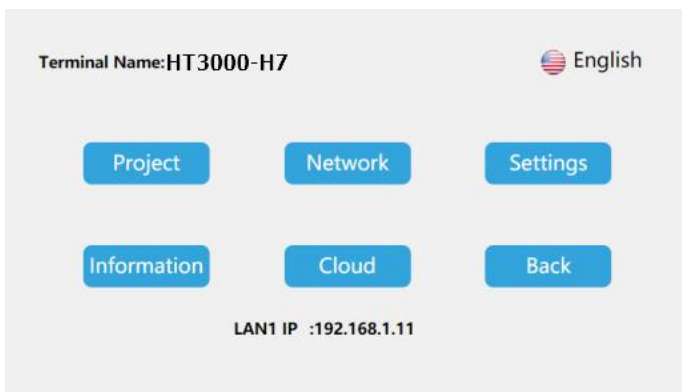

- Exit background settings

On the HMI background settings interface, click [Back] to exit the background settings and enter the project running interface.